











INSTALLATION INSTRUCTIONS



NOVA2 DIRECT/INDIRECT
MODELS # NOV2DI
REV. 4



WARNING

-  **THIS PRODUCT MUST BE INSTALLED IN ACCORDANCE WITH THE APPLICABLE INSTALLATION CODE BY A PERSON FAMILIAR WITH THE CONSTRUCTION AND OPERATION OF THE PRODUCT AND THE HAZARDS INVOLVED.**
CE PRODUIT DOIT ETRE INSTALLE SELON LE CODE D'INSTALLATION PERTINENT, PAR UNE PERSONNE QUI CONNAIT BIEN LE PRODUIT ET SON FONCTIONNEMENT AINSI QUE LES RISQUES INHERENTS.
-  **DISCONNECT POWER PRIOR TO ANY INSTALLATION.**
DEBRANCHEZ LE COURANT AVANT TOUTE INSTALLATION.
-  **CAP ALL WIRING CONNECTIONS WITH UL APPROVED WIRE CONNECTORS.**
COUVRIRE TOUTES LES CABLES AVEC DES CONNECTIONS APPROUVEES (UL).
-  **VERIFY SUPPLY VOLTAGE MEETS LUMINAIRE LABEL SPECIFICATIONS.**
VERIFIEZ QUE LA TENSION SOIT COMPATIBLE AVEC LES CARACTERISTIQUES DU LUMINAIRE MARQUE SUR LETIQUETTE.
-  **ALLOW FIXTURE TO COOL BEFORE TOUCHING HEATSINK OR LIGHT SOURCE.**
LAISSEZ LE PROJECTEUR REFOIDIR AVANT DE TOUCHER LE RADIATEUR OU LA SOURCE DE LUMIERE.
-  **DO NOT ATTEMPT TO OPEN OR MAKE REPAIRS INSIDE LUMINAIRE.**
NE PAS TENTER DOUVRIRE OU DE FAIRE DES REPARATINS A L'INTERIEUR DU LUMINAIRE.
-  **AVOID DIRECT VIEWING OF LIGHT SOURCE.**
EVITEZ DE REGARDER DIRECTEMENT LA SOURCE LUMINEUSE.
-  **THIS PRODUCT MUST BE INSTALLED BY A QUALIFIED ELECTRICIAN.**
CE PRODUIT DOIT ETRE INSTALLE PAR UN ELECTRICIEN QUALIFIE.
-  **SUITABLE FOR UNDER-CABINET MOUNT.**
ADAPTE POUR SOUS-CABINET MOUNT.
-  **SUITABLE FOR DAMP LOCATION.**
ADAPTE POUR DES ENDROITS HUMIDES.
-  **MIN 105° C SUPPLY CONDUCTORS.**
MIN 105° C ALIMENTATION CONDUCTEURS.
-  **SUITABLE FOR CONTINUOUS ROW MOUNTING.**
ADAPTE POUR CONTINU ROW MONTAGE.

6/13/2019 - PAGE 1

INSTALLATION INSTRUCTIONS

NOVA2 DIRECT/INDIRECT
MODELS # NOV2DI
REV. 4

Provided Parts List

The components have been packed to avoid damage during transit. Inspect the components to confirm there is no physical damage. Do not install damaged components. The carton contains the following:

- ★ Nova2 Direct/Indirect Fixture
- ★ Mounting Brackets and Hardware (may be attached to fixture depending on mounting type)
- ★ Lens Joiner Bands (shipped separate from fixtures for Continuous Row installations)
- ★ Installation Manual

Mounting

Inspect mounting location for damage. Make sure the structure can support the weight of the Nova2 fixture. Follow all UL, NEC and minimum load rating guidelines when selecting and installing mounting hardware for the fixture.

- ★ Fixture Weights:
Nova2 - 4' (5lbs. max) / 8' (10lbs. max)

Pendant Mount Instructions

Pendant Mount Fixtures come standard with adjustable gripper that accepts 1/16" aircraft cable. Adjust gripper location by loosening 4-40 x .313" screw and sliding into position anywhere along the top of the fixture.



INSTALLATION INSTRUCTIONS

NOVA2 DIRECT/INDIRECT
MODELS # NOV2DI
REV. 4



Rotational Mount Instructions

Loosen the rotational mount brackets and slide to the desired position anywhere between the middle and end of the fixture. Tighten the provided screw to lock the bracket in place on the fixture. Position fixture and secure the rotational mount bracket to the structure with appropriate hardware.



Nova2 Direct/Indirect Installation

Individual Fixture Installation

1. Power must be turned OFF prior to disconnecting or reconnecting the Nova2 Direct/ Indirect fixture
2. If fixture is not fitted with existing plug, connect fixture wiring to line side wires. Use only UL listed wiring devices. Purple and Gray leads are used for 0-10 dimming ONLY. Cap wires if not used (see below). The wiring inside the fixtures is rated 14AWG. Line side wiring connected by the installer must be rated for the load per (NEC) National Electric Code and/or local electric code. *

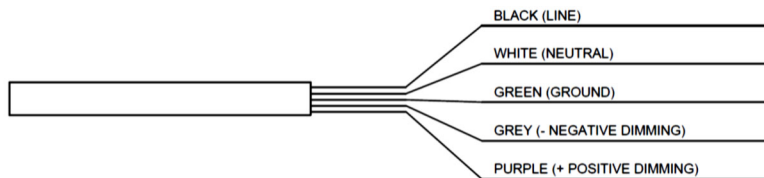

*If your product is configured to have an EM circuit, EM Battery circuit or a separate circuit for dual switching, the above configuration will include an additional BLUE wire to be terminated on the additional circuit mains wiring.

3. Restore power and verify operation.

INSTALLATION INSTRUCTIONS

NOVA2 DIRECT/INDIRECT
MODELS # NOV2DI
REV. 4



Nova2 Direct/Indirect Installation (continued)

Conduit Feed Top Option (CFT) Installation

1. Power must be turned OFF prior to disconnecting or reconnecting the Nova2 Direct fixture
2. Each Nova2 Direct fixture, utilizing the CFT option, is provided with fixture leads on one end of the fixture and are fed thru a 7/8" opening in the top of the fixture.
3. Begin by removing the (4) four screws securing the access plate to access the wiring compartment.
4. Connect conduit to access plate at 7/8" hole, ensuring the lock nut is tight.
5. Connect fixture wiring to line side wires. Use only UL listed wiring devices. Purple and Gray leads are used for 0-10 dimming ONLY. Cap wires if not used (see below). The wiring inside the fixtures is rated 14AWG. Line side wiring connected by the installer must be rated for the load per (NEC) National Electric Code and/or local electric code. *

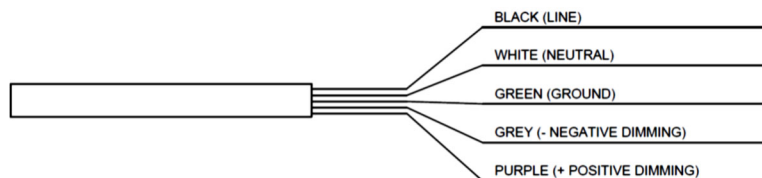

*If your product is configured to have an EM circuit, EM Battery circuit or a separate circuit for dual switching, the above configuration will include an additional BLUE wire to be terminated on the additional circuit mains wiring.

6. After wiring connection are made, tuck the connections and wiring back into the wiring compartment and secure the access plate with the (4) four screws removed earlier.
7. Restore power and verify operation.

INSTALLATION INSTRUCTIONS

NOVA2 DIRECT/INDIRECT
MODELS # NOV2DI
REV. 4

Nova2 Direct Installation (continued)

Continuous Row Installation

1. Power must be turned OFF prior to disconnecting or reconnecting the Nova2 Direct fixture

Max Length per Fixture Run	
Voltage	Std/Low Output
120-276	102 Ft
277	238 Ft

2. Identify different fixture types for each row

Starter Fixture: Stripped wires/cord on one side, male connector on the other side.

Middle Fixture: Female connector on one side, male connector on the other side.

End Fixture: Female connector on one side, closed end cap on the other side

3. Attach **Starter Fixture** to structure. Connect **Starter Fixture** wiring to line side wires. Use only UL listed wiring devices. Purple and Gray leads are used for 0-10 dimming ONLY. Cap wires if not used (see below). The wiring inside the fixtures is rated 14AWG. Line side wiring connected by the installer must be rated for the load per (NEC) National Electric Code and/or local electric code. *
4. Support **Middle Fixture** or **End Fixture** depending on row length.
5. Connect wiring harness of fixture 1 to harness of fixture 2

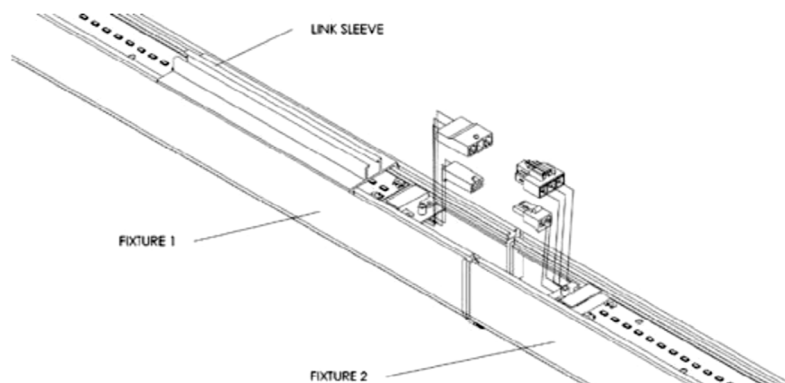

INSTALLATION INSTRUCTIONS

NOVA2 DIRECT/INDIRECT
MODELS # NOV2DI
REV. 4



Nova2 Direct/Indirect Installation (continued)

6. Tuck harness into the fixture and slide the external sleeve from fixture 1 over to fixture 2

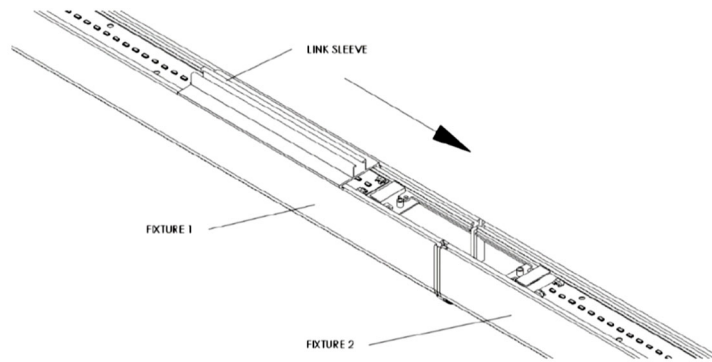

7. Line up slots in external sleeve with holes in fixture and lock external sleeve to both fixture 1 and fixture 2

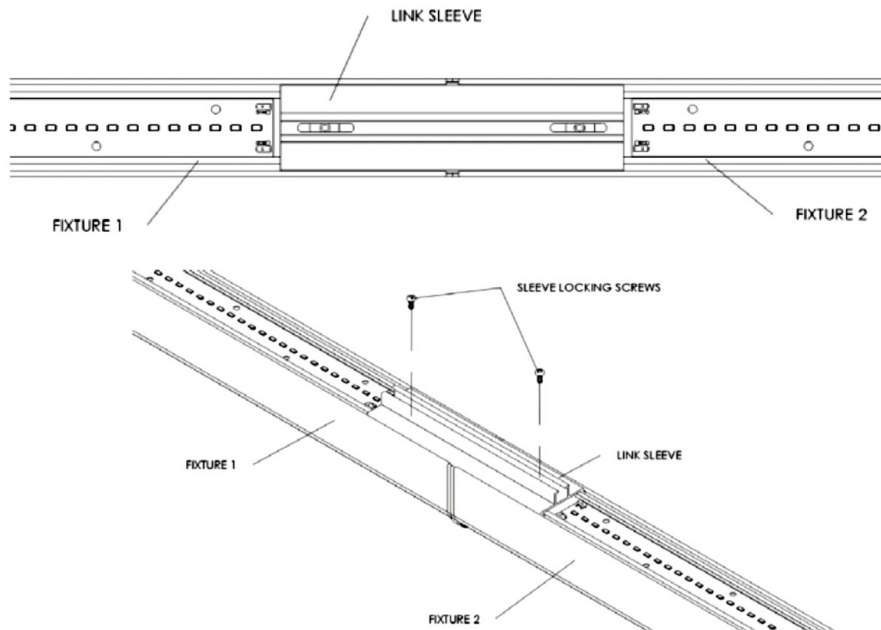

8. Place lens joiner band between lenses. Confirm engagement with both end caps.
9. Repeat steps 3 through 7 for additional fixtures.
10. Restore power and verify operation.