













INSTALLATION INSTRUCTIONS



SCULPTURA DIRECT
MODELS # SCULD
REV. 1



WARNING

-  **THIS PRODUCT MUST BE INSTALLED IN ACCORDANCE WITH THE APPLICABLE INSTALLATION CODE BY A PERSON FAMILIAR WITH THE CONSTRUCTION AND OPERATION OF THE PRODUCT AND THE HAZARDS INVOLVED.**
CE PRODUIT DOIT ETRE INSTALLE SELON LE CODE D'INSTALLATION PERTINENT, PAR UNE PERSONNE QUI CONNAIT BIEN LE PRODUIT ET SON FONCTIONNEMENT AINSI QUE LES RISQUES INHERENTS.
-  **DISCONNECT POWER PRIOR TO ANY INSTALLATION.**
DEBRANCHEZ LE COURANT AVANT TOUTE INSTALLATION.
-  **CAP ALL WIRING CONNECTIONS WITH UL APPROVED WIRE CONNECTORS.**
COUVRIR TOUTES LES CABLES AVE DES CONNECTIONS APPROUVES (UL).
-  **VERIFY SUPPLY VOLTAGE MEETS LUMINAIRE LABEL SPECIFICATIONS.**
VERIFIEZ QUE LA TENSION SOIT COMPATIBLE AVEC LES CARACTERISTIQUES DU LUMINAIRE MARQUE SUR LETIQUETTE.
-  **ALLOW FIXTURE TO COOL BEFORE TOUCHING HEATSINK OR LIGHT SOURCE.**
LAISSEZ LE PROJECTEUR REFOIDIR AVANT DE TOUCHER LE RADIATEUR OU LA SOURCE DE LUMIERE.
-  **DO NOT ATTEMPT TO OPEN OR MAKE REPAIRS INSIDE LUMINAIRE.**
NE PAS TENTER DOUVRIRE OU DE FAIRE DES REPARATINS A L'INTERIEUR DU LUMINAIRE.
-  **AVOID DIRECT VIEWING OF LIGHT SOURCE.**
EVITEZ DE REGARDER DIRECTMENT LA SOURCE LUMINEUSE.
-  **THIS PRODUCT MUST BE INSTALLED BY A QUALIFIED ELECTRICIAN.**
CE PRODUIT DOIT ETRE INSTALLE PAR UN ELECTRICIEN QUALIFIE.
-  **SUITABLE FOR UNDER-CABINET MOUNT.**
ADAPTE POUR SOUS-CABINET MOUNT.
-  **SUITABLE FOR DAMP LOCATION.**
ADAPTE POUR DES ENDROITS HUMIDES.
-  **MIN 105° C SUPPLY CONDUCTORS.**
MIN 105° C ALIMENTATION CONDUCTEURS.
-  **SUITABLE FOR CONTINUOUS ROW MOUNTING.**
ADAPTE POUR CONTINU ROW MONTAGE.

12/30/2019 - PAGE 1

INSTALLATION INSTRUCTIONS

SCULPTURA DIRECT
MODELS # SCULD
REV. 1

Provided Parts List

The components have been packed to avoid damage during transit. Inspect the components to confirm there is no physical damage. Do not install damaged components. The carton contains the following:

- ★ Sculptura Direct (SCULD) fixture
- ★ Mounting Brackets and Hardware (may be attached to fixture depending on mounting type)
- ★ Lensing (shipped separate from fixtures for Continuous Row installations)
- ★ Installation Manual

Mounting

Inspect mounting location for damage. Make sure the structure can support the weight of the SCULD fixture. Follow all UL, NEC and minimum load rating guidelines when selecting and installing mounting hardware for the fixture.

- ★ Fixture Weights:
SCULD - 4' (10lbs. max) / 8' (20lbs. max)

Pendant Mount Instructions

Pendant Mount Fixtures come standard with adjustable gripper that accepts 1/16" aircraft cable. Adjust gripper location by loosening 4-40 x .313" screw and sliding into position anywhere along the top of the fixture.



(Mounting accessories shown in contrasting color to provide detail. Fixtures are shipped with matching mounting accessories, unless specified otherwise.)

INSTALLATION INSTRUCTIONS

SCULPTURA DIRECT
MODELS # SCULD
REV. 1



Surface Mount Instructions

1. Remove the side screws that fasten the top portions of the brackets to the lower portions attached to the fixture. Lift the top portions off the fixture.
2. Ensuring the surface can support the weight of the fixture, secure the top portions of the brackets to the surface at the desired locations.
3. Loosen the 4 screws in the lower portions of the brackets attached to the fixture and slide along the fixture to match the locations of the top portions mounted to the surface.
4. After the electrical connections have been made, match the tabs on the top bracket sections to the slot in the bottom brackets, and pivot fixture into place.
5. Secure fixture in place by reattaching the side screw provided.

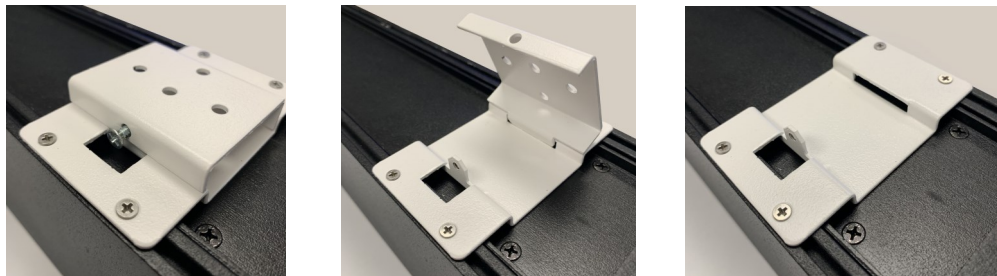

Wall Mount Instructions

1. Remove outside portion of mounting brackets by removing outside top screw.
2. Ensuring the surface can support the weight of the fixture, secure the outside portions of the brackets to the wall in the desired locations.
3. Loosen the 2 screws in the top portions of the brackets attached to the fixture and slide along the fixture to match the locations of the outside portions mounted to the wall.
4. After the electrical connections have been made, match the tabs on the top bracket to the slot in the outside brackets, and pivot fixture into place.
5. Secure fixture in place by reattaching the outside top screw provided.

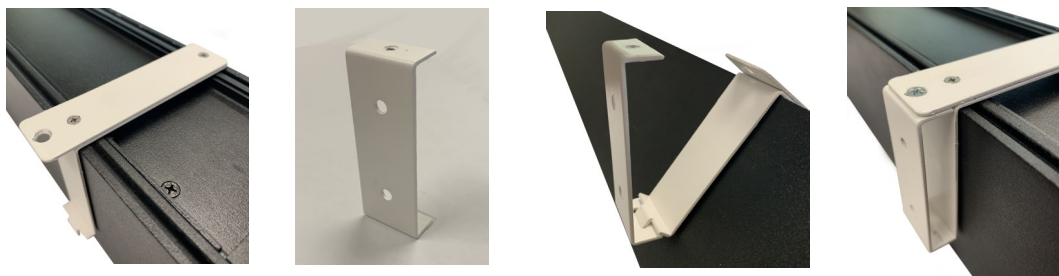

INSTALLATION INSTRUCTIONS

SCULPTURA DIRECT
MODELS # SCULD
REV. 1



SCULPTURA Direct Installation

Individual Fixture Installation

1. Power must be turned OFF prior to disconnecting or reconnecting the SCULPTURA Direct
2. If fixture is not fitted with existing plug, connect fixture wiring to line side wires. Use only UL listed wiring devices. Purple and Gray leads are used for 0-10 dimming ONLY. Cap wires if not used (see below). The wiring inside the fixtures is rated 14AWG. Line side wiring connected by the installer must be rated for the load per (NEC) National Electric Code and/or local electric code. *

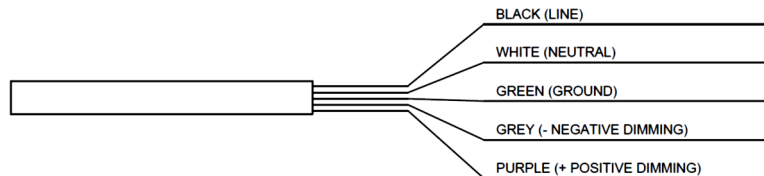

*If your product is configured to have an EM circuit, EM Battery circuit or a separate circuit for dual switching, the above configuration will include an additional BLUE wire to be terminated on the additional circuit mains wiring.

3. Restore power and verify operation.

INSTALLATION INSTRUCTIONS

SCULPTURA DIRECT
MODELS # SCULD
REV. 1

SCULPTURA Direct Installation (continued)

Continuous Row Installation

1. Power must be turned OFF prior to disconnecting or reconnecting the SCULPTURA Direct fixture

| Max Length per Fixture Run | | |
|----------------------------|-----------------|-------------|
| Voltage | Standard Output | High Output |
| 120-276 | 136 Ft | 100 Ft |
| 277 | 316 Ft | 236 Ft |

2. Identify different fixture types for each row
 - Starter Fixture:** Stripped wires/cord on one side, male connector on the other side
 - Middle Fixture:** Female connector on one side, male connector on the other side
 - End Fixture:** Female connector on one side, closed end cap on the other side
 - Continuous Lensing:** Box labelled for the total length of the row
3. Attach **Starter Fixture** to structure. Connect **Starter Fixture** wiring to line side wires. Use only UL listed wiring devices. Purple and Gray leads are used for 0-10 dimming ONLY. Cap wires if not used (see below). The wiring inside the fixtures is rated 14AWG. Line side wiring connected by the installer must be rated for the load per (NEC) National Electric Code and/or local electric code. *
4. Support **Middle Fixture** or **End Fixture** depending on row length
5. Attach **Middle Fixture** or **End Fixture**, depending on row length, to the **Starter Fixture** by lining up the position pins and bringing the two fixtures together. Fasten the latch to the second fixture and pull in the opposite direction to lock it in place.

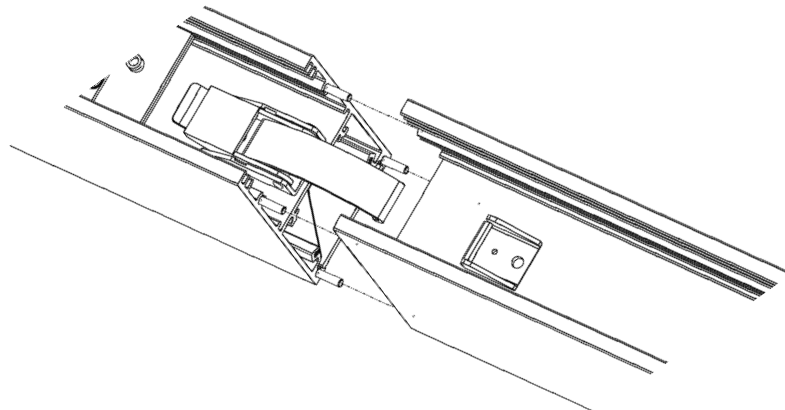

INSTALLATION INSTRUCTIONS

SCULPTURA DIRECT
MODELS # SCULD
REV. 1

SCULPTURA Direct Installation (continued)

6. Connect wiring harness of fixture 1 to harness of fixture 2

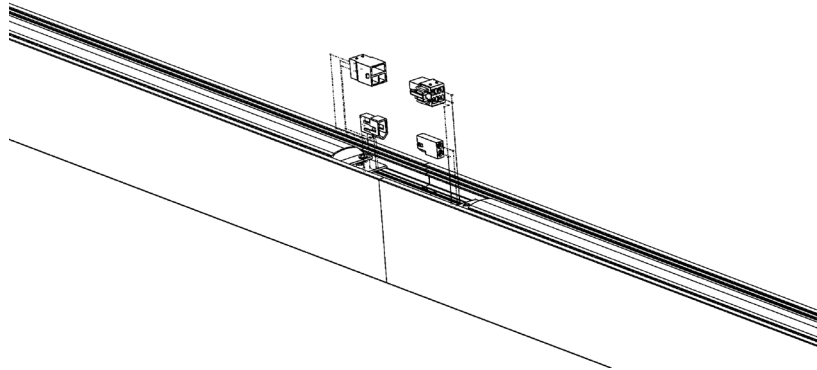

7. Tuck harness into the fixture and slide the external sleeve from fixture 1 over to fixture 2. Line up holes in external sleeve with holes in fixture and lock external sleeve to both fixture 1 and fixture 2

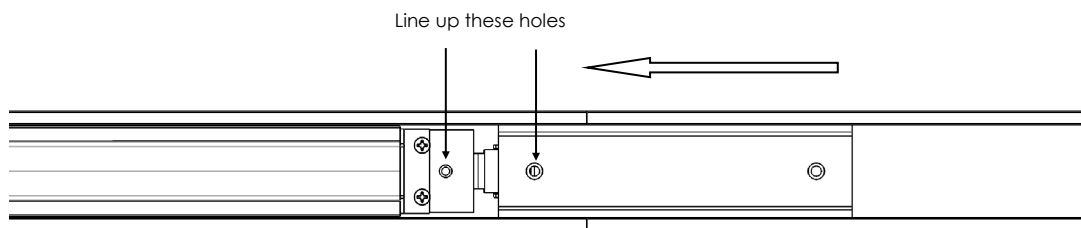

8. Repeat steps 3 through 7 for additional fixtures.
9. Remove closed end cap from End Fixture
10. Pull continuous lens from End Fixture to Starter Fixture (see continuous lens instruction for more information)
11. Fasten closed end cap to End Fixture
12. Restore power and verify operation.