

StarPower Wide

Type:	
Project:	
REP/Agent:	
Order #:	

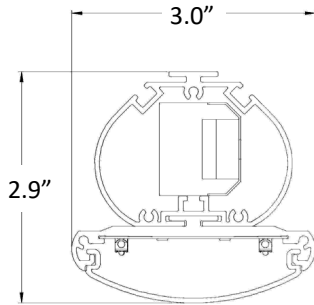

DIMENSIONS



ORDERING LOGIC

SPW	-	LENGTH	OUTPUT	-	SD	-	CCT (80+ CRI)	-	FINISH
SPW	-	4=4' 8=8'	S=Standard H=High XXX=Custom LPF	-	SD=SatinIce Diffused	-	30K=3000K 35K=3500K 40K=4000K 50K=4000K	-	STANDARD CA=Clear Anodize CUSTOM PO=Powder Other
MOUNTING**			VOLTAGE			OPTIONS			
CABLES WITH CANOPY KITS ACW05=White Cord 5' ACW10=White Cord 10' ACB05=Black Cord 5' ACB10=Black Cord 10' CABLES WITH LOOPS ALW10=White Cord 10' ALB10=Black Cord 10' SURFACE MOUNTS SMW=Surface Mount, 10' White Cord SMB =Surface Mount, 10' Black Cord ROTATIONAL MOUNTS RMW=Rotational Mount, 10' White Cord RMB =Rotational Mount, 10' Black Cord			U=120-277V C=347V			SPECIALTY DRIVERS (Standard driver is 0-10V, dim to 1% output current) DT1=eldoLED EcoDrive Dim to 1% (0-10V) DTZ=eldoLED SoloDrive Dim to 0% (0-10V) PSRD=Philips Sensor Ready (DALI) Driver LDE1=Lutron Hi-Lume EcoSystem LED driver with Soft-on, Fade-to-Black dimming BATTERIES EMB6=6W EM Battery EMB10=10W EM Battery SENSORS DM=Daylight/Motion Sensor OTHER CRI9050=Minimum 90 CRI (R9 50) CFT=Conduit Feed Through (See page 3)			

EXAMPLE: SPW-4S-SD-35K-CA-ALW10-U-EMB10

FEATURES

- Available in 4' and 8' individual fixtures
- Two standard lumen packages
- Efficacy up to 155 lm/W
- Soft diffuse direct lighting
- Clear anodize finish
- Custom powder coat colors available upon request
- Approved for dry and damp locations
- 0-10v dimming is standard
- Dim to 1% of output current is standard
- CA Title 24 / JA8 installation compatible



Intertek



LUMEN PACKAGES

Based on 3500K CCT. Other CCT available.

MODEL	LUMENS	INPUT WATTS	Lm/W
SPW-8-S-35K	12,540	87	144
SPW-8-H-35K	25,080	174	144

Type:	
Project:	
REP/Agent:	
Order #:	

MOUNTING OPTIONS

ACxxx (Aircraft Cable with Canopy) - Drywall, Solid, Tile (On-Grid), Tile (Off-Grid)

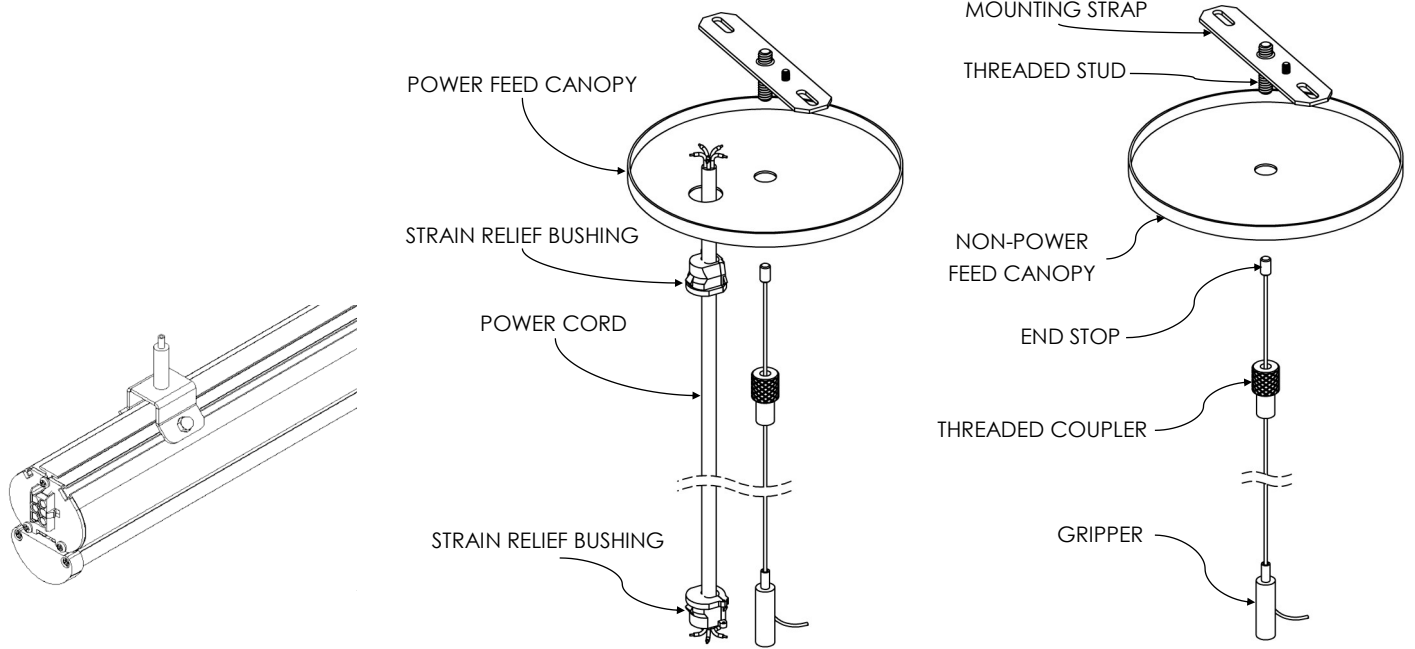

ALxxx (Aircraft Cable with Loops)

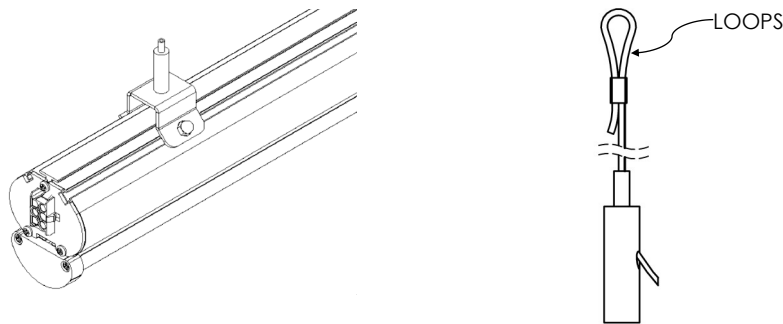

SMx (Surface Mount)

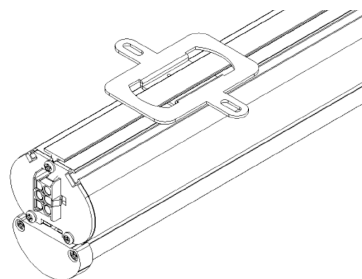

RMx (Rotational Mount)

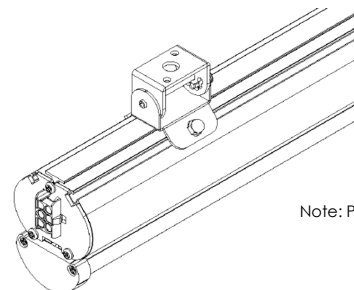

Note: Pendants by others.

StarPower Wide

Type:	
Project:	
REP/Agent:	
Order #:	

Surface Mount Options

When fixtures are ordered with the **SM**=Surface Mount option, the fixture will be manufactured with an end plate that has an opening for a 1/2" connector on the feed end, and a full end cap on the other end.



If the **CFT**=Conduit Feed (Through) is specified, the fixture will be manufactured with an additional end plate that has an opening for a 1/2" connector on the opposite end of the fixture. Thru wires will be provided from one end of the fixture to the other. Conduit can then be run to another fixture.



Example



PLEASE NOTE: The **CFT**=Conduit Feed (Through) option should **not** be used to link fixtures together in continuous lengths over 4' or 8'. For that application, the StarPower Link series should be used.

Type:	
Project:	
REP/Agent:	
Order #:	

PERFORMANCE

***Bold indicates DLC Premium 5.0 Listed**

STANDARD OUTPUT - 80+ CRI

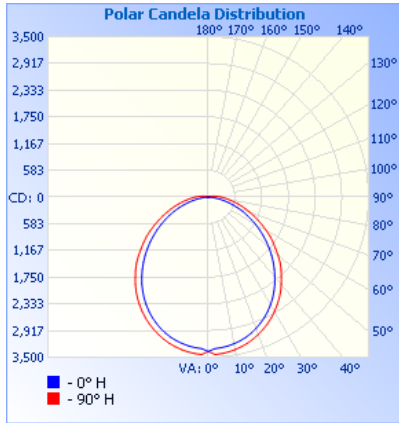

Model	Lumens	Watts	LPW
SP-W-4S-30K	8,724	68	128.1
SP-W-4S-35K	9,565	68	140.5
SP-W-4S-40K	9,631	68	141.4
SP-W-4S-45K	9,698	68	142.4
SP-W-4S-50K	9,764	68	143.4

Model	Lumens	Watts	LPW
SP-W-8S-30K	12,197	87	140.0
SP-W-8S-35K	12,540	87	143.9
SP-W-8S-40K	12,883	87	147.8
SP-W-8S-45K	13,226	87	151.8
SP-W-8S-50K	13,569	87	155.7

HIGH OUTPUT - 80+ CRI

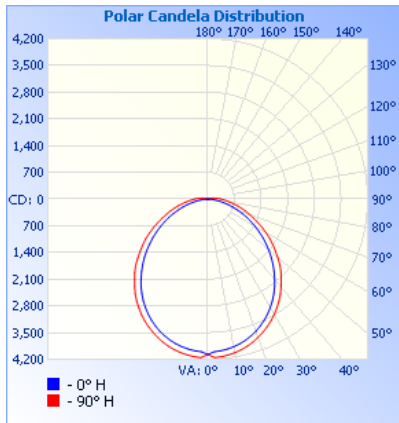

Model	Lumens	Watts	LPW
SP-W-4H-35K	11,558	90	127.9
SP-W-4H-40K	11,819	90	130.8
SP-W-4H-45K	12,081	90	133.7
SP-W-4H-50K	12,342	90	136.6

Model	Lumens	Watts	LPW
SP-W-8H-35K	23,116	116	140.0
SP-W-8H-40K	23,638	116	143.2
SP-W-8H-45K	24,162	116	146.4
SP-W-8H-50K	24,684	116	149.6

StarPower Wide

Type:	
Project:	
REP/Agent:	
Order #:	

SPECIFICATIONS

Housing

Nominal 3" x 3" dual housings of continuous extruded 6063 T5 aluminum .

Color

The housing color is available in clear anodize. Custom powder coat options are available. Consult factory.

Luminaire Length

Fixtures are available in 4' and 8' standard lengths (see dimensions chart on this page).

Source

Two standard lumen packages are available in four color temperature options (3000K, 3500K, 4000K and 5000K) — all within 2.5 MacAdam ellipses.

Dimming Driver

Universal Lighting Technologies (ULT) Everline series of LED drivers allows tunable output currents to achieve infinite configurations of output. UL Class 2 recognized. 0-10v interface can be wired as Class 1 or Class 2 circuit. Included 2.5Kw ring and wave overcurrent protection, isolation of each individual output and a fully potted driver to protect from heat and vibration. Power factor <.93

Certification

Intertek cETLus Listed. DLC Premium listed options are available. RoHS (Restriction of Hazardous Substances) and Buy American Act compliant.

Environment

Suitable for dry and damp locations.
Operating temp.: -40°C to +50°C
-40°F to +122°F

Battery (optional)

Philips Bodine lithium ion battery providing up to 780lm(6W) or up to 1300lm(10W) for 90 minutes. UL924 listed. Class 2 compliant. Meets Title 20 CEC (California Energy Commission) efficiency standards.

Packaging

Sustainably manufactured outside cardboard box and biodegradable, protective poly-foam luminaire inserts.

COMPANION PRODUCTS

StarLink Wide

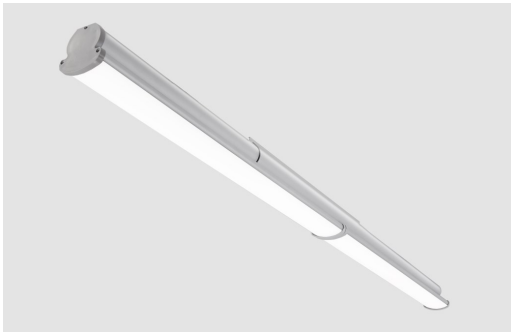

DIMENSIONS

MODEL	NOMINAL LENGTH	LUMINAIRE LENGTH	RACEWAY LENGTH	WEIGHT
SPW-4x	4ft.	48.0" (1,219mm)	45.6" (1,158mm)	8 lbs. max (3.6 kg)
SPW-8x	8ft.	96.0" (2,348mm)	93.6" (2,377mm)	16 lbs. max (6.4 kg)

WARRANTY

5-year limited warranty. Complete warranty terms can be located at:

http://www.starteklightingamerica.com/images/pdf/warranty/StarPower_Warranty.pdf

Note: Actual performance may differ as a result of installation environment and final application. All values are design or typical values, measured under laboratory conditions, at 25°C (77°F) .