

Type:	
Project:	
REP/Agent:	
Order #:	

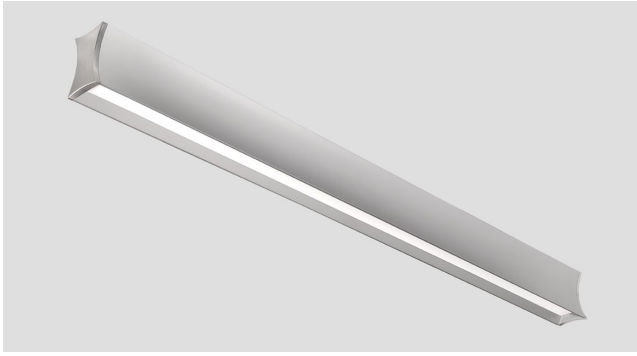

## DIMENSIONS

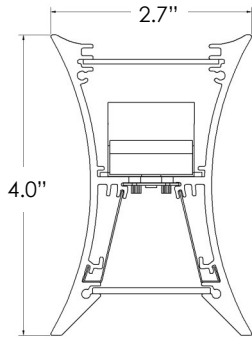

## FEATURES

- **Continuous lensing standard– runs up to 200'**
- Extruded aluminum single piece housing
- 4' and 8' individual units, or continuous rows
- Linear runs with proprietary joiner design
- Light levels can be set at the factory
- Efficacy up to 125 lm/W
- Soft diffuse direct lighting
- Textured powder coat or clear anodize finish
- Approved for dry and damp locations
- 0-10v dimming is standard
- Dim to 1% of output current is standard
- 90 CRI (R9 50min) available
- CA Title 24 / JA8 installation compatible
- (Consult factory for TM21, TM30, LM79 and LM80.)



## ORDERING LOGIC

XBEAMD	LENGTH	LUMENS PER FOOT	DISTRIBUTION	CCT	CRI
<b>xx</b> = Run Length	<b>350</b> = 350LPF	<b>SD</b> = SatinIce Diffuse	<b>30K</b> = 3000K	<b>80</b> = 80	
<b>Sxx</b> = Symmetric Run Length	<b>500</b> = 500LPF	<b>WD</b> = Wide Diffuse	<b>35K</b> = 3500K	<b>90</b> = 90 (R9 50 min)	
	<b>750</b> = 750LPF		<b>40K</b> = 4000K		
	<b>1000</b> = 1000LPF		<b>50K</b> = 5000K		
	<b>XXX</b> = Custom LPF		<b>TW</b> = Tunable White! (2700-6500K)		

FINISH	MOUNTING	VOLTAGE	ELECTRICAL	OPTIONS
<b>STANDARD</b>	<b>CABLES WITH CANOPY KITS</b>	U= 120-277	1C= Single Circuit	<b>SPECIALTY DRIVERS (Standard driver is 0-10V, dim to 1% output current)</b>
PW= Powder Coat White	ACW05= White Cord 5'	C= 347	MC= Multiple Circuits <i>(multiple switch legs across run length)</i>	DT1= eidoLED EcoDrive Dim to 1% (0-10V)
PB= Powder Coat Black	ACW10= White Cord 10'		EC= Emergency Circuit <i>(separate power drops for EC fixtures)</i>	DTZ= eidoLED SoloDrive Dim to 0.1% (0-10V)
CA= Clear Anodize	ACB05= Black Cord 5'		GTD= Generator Transfer Device	PSRD= Philips Sensor Ready (DALI) Driver
	ACB10= Black Cord 10'			LDE1= Lutron Hi-Lume EcoSystem LED driver with Soft-on, Fade-to-Black
<b>PREMIUM</b>	<b>CABLES WITH LOOPS</b>			TW-A= Tunable White, 0-10V <sup>2</sup>
RALxxxx= Powder Coat	ALW10= White Cord 10'			TW-EL= eidoLED DUALdrive Tunable White (DALI) <sup>2</sup>
RAL xxxx	ALB10= Black Cord 10'			PSQ02U= Lutron T-Series 1% 2-Channel Tunable White driver <sup>2</sup>
<b>CUSTOM</b>	<b>STEM WITH CANOPY KITS</b>			<b>BATTERIES</b>
PO= Powder Other	STEMWxx= Stem White, xx"			#EMB6= 6W EM Battery } (# indicates quantity, not compatible with 2' fixtures)
	STEMBxx= Stem Black, xx"			#EMB10= 10W EM Battery }
				<b>SENSORS</b>
				AWN-R-W= Lutron Athena Wireless Node (RF only) <sup>3</sup> - White Finish
				AWN-R-B= Lutron Athena Wireless Node (RF only) <sup>3</sup> - Black Finish

EXAMPLE: XBEAMD-40-750-WD-35K-90-PW-ACW10-U-1C-1EMB10

<sup>1</sup> Tunable White Driver must be specified in options  
<sup>2</sup> 50 Watt Max. Dual driver required for higher fixture wattage  
<sup>3</sup> D4i driver for static & DALI-2 Type 8 for tunable.

Type:	
Project:	
REP/Agent:	
Order #:	

## MOUNTING OPTIONS

### ACxxx (Aircraft Cable with Canopy) - Drywall, Solid, Tile (On-Grid), Tile (Off-Grid)

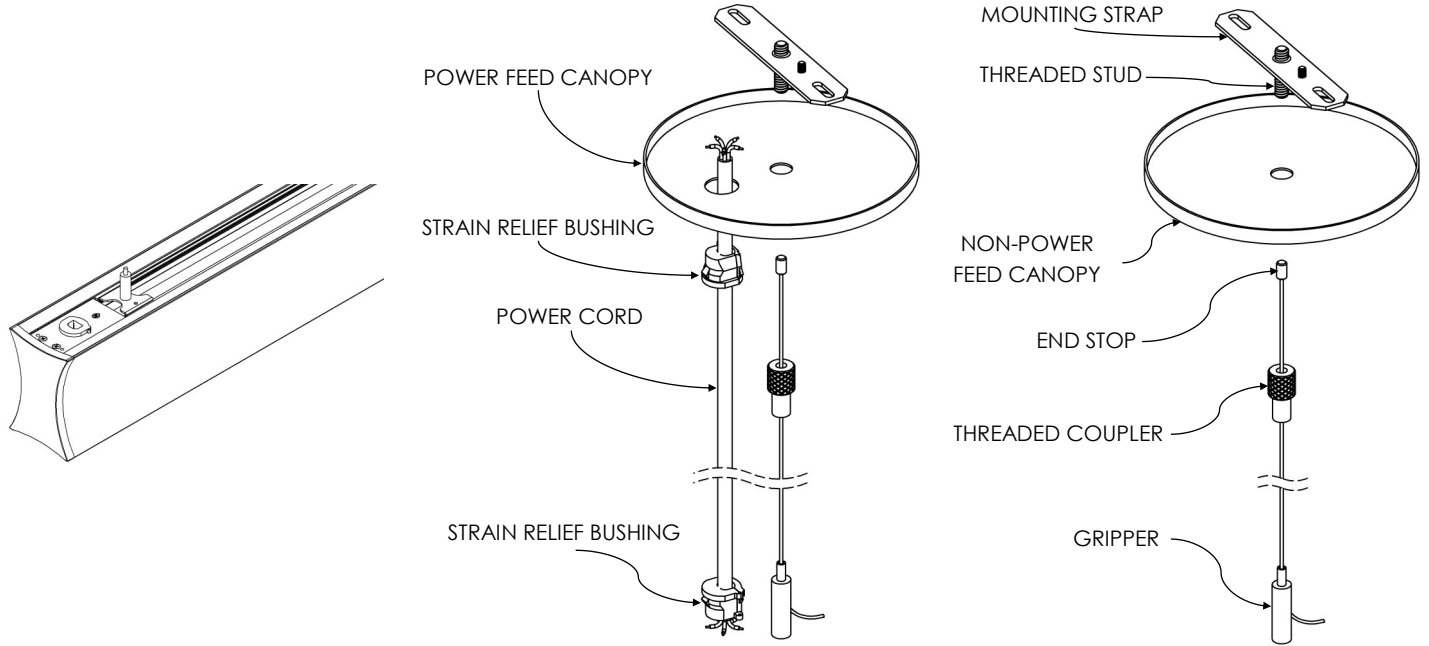

### ALxxx (Aircraft Cable with Loops)

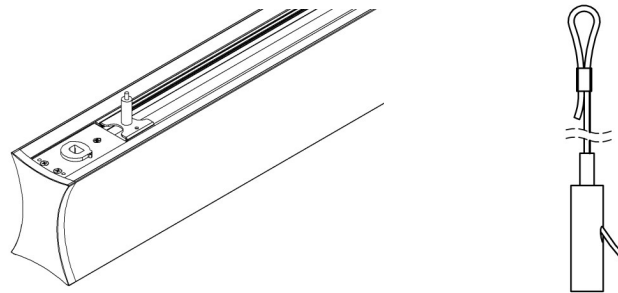

**POWER CORD & FIRST MOUNT DETAIL**

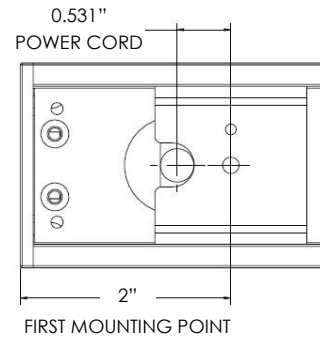

### STEMWxx, STEMBxx (Stem Mount)

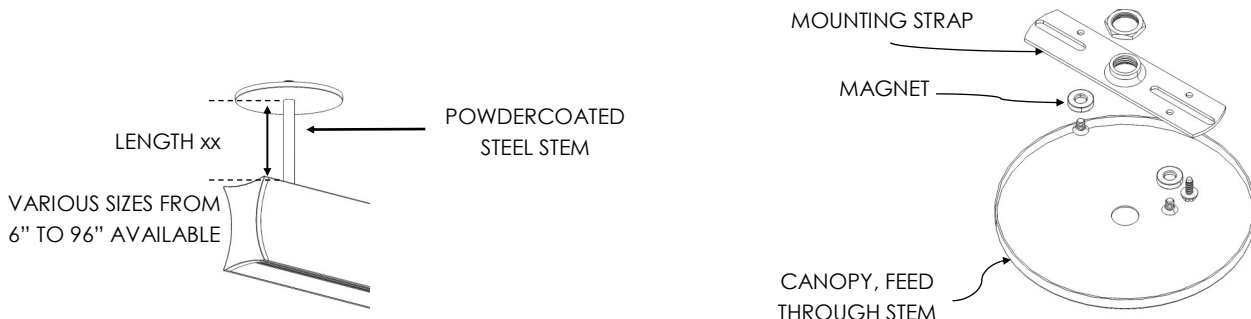

Type:	
Project:	
REP/Agent:	
Order #:	

## ROW CONFIGURATIONS

### xx (Run Length)

The standard construction of run lengths is to build with as many 8' sections as possible and finish the run with a shorter length fixture if necessary.

Examples of the standard construction of runs over 8' are as follows:

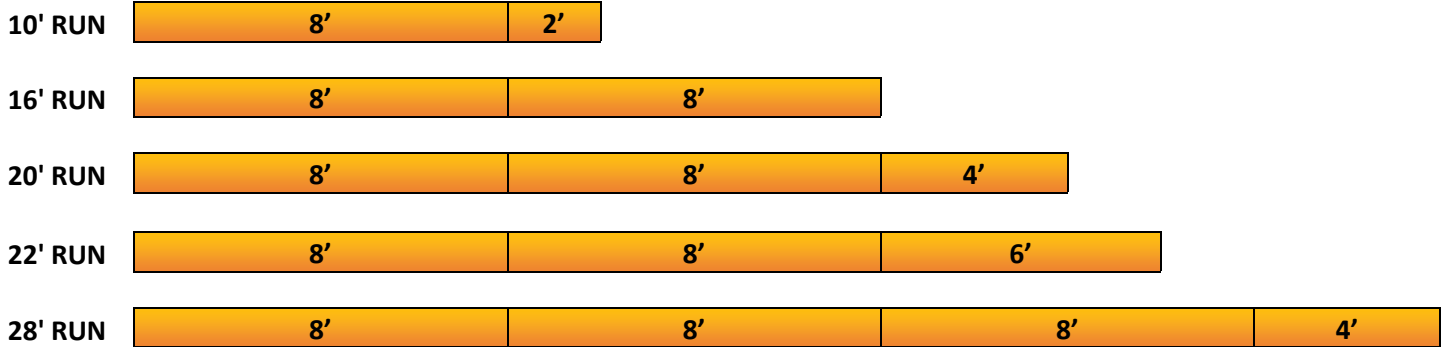

### SRxx (Symmetric Run)

The construction of SRxx is to build with equal length fixtures. Please indicate this on your P.O. when placing your order.

Examples of symmetric construction of runs over 8' are as follows:

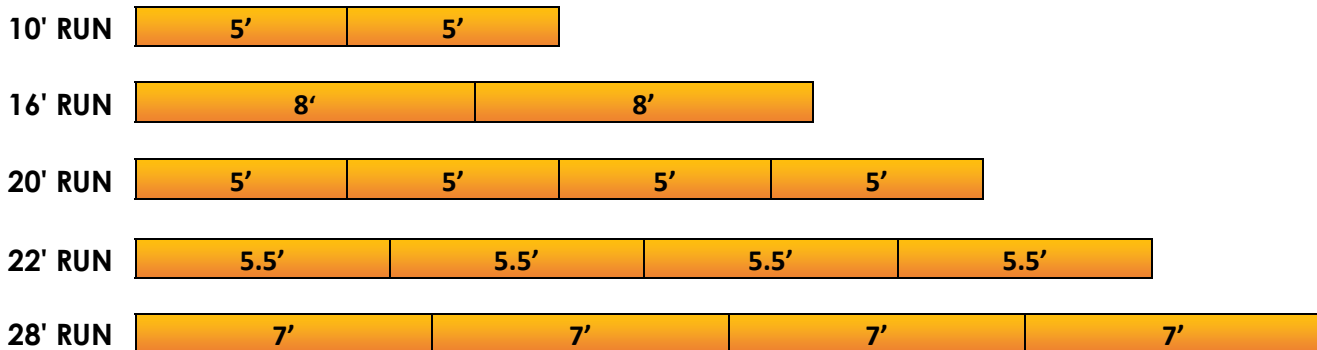

## MOUNTING LOCATIONS

Each starter or individual fixture will be provided with (2) mounting supports (●). Each additional fixture will be provided with (1) support which can be located anywhere along the 2nd half of the fixture (highlighted below):

Examples of continuous run mounting locations are as follows:

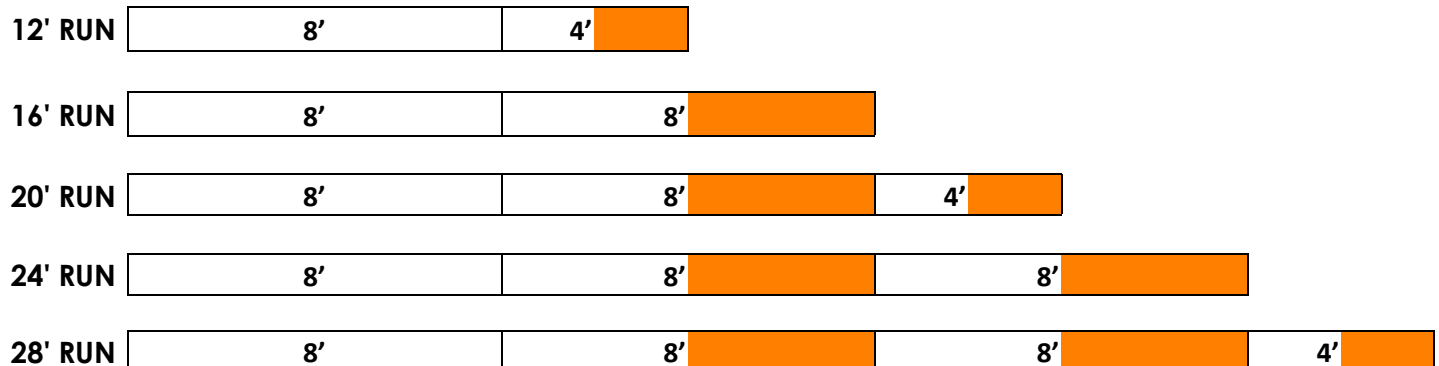

Type:	
Project:	
REP/Agent:	
Order #:	

## PERFORMANCE

### XBEAMD-X-750-SD (80+ CRI)

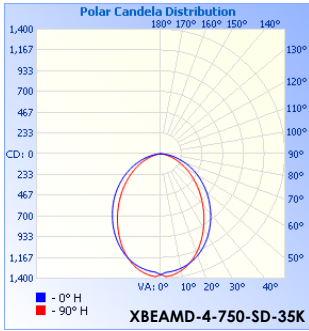

Model	Lumens	Watts	LPW
XBEAMD-4-750-SD-30K	3,000	27	110
XBEAMD-4-750-SD-35K	3,000	26	114
XBEAMD-4-750-SD-40K	3,000	26	117
XBEAMD-4-750-SD-50K	3,000	25	122

Model	Lumens	Watts	LPW
XBEAMD-8-750-SD-30K	6,000	53	114
XBEAMD-8-750-SD-35K	6,000	51	117
XBEAMD-8-750-SD-40K	6,000	50	120
XBEAMD-8-750-SD-50K	6,000	48	125

### XBEAMD-X-750-WD (80+ CRI)

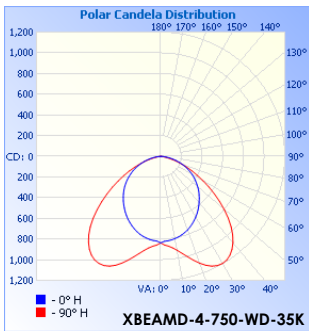

Model	Lumens	Watts	LPW
XBEAMD-4-750-WD-30K	3,000	27	110
XBEAMD-4-750-WD-35K	3,000	26	114
XBEAMD-4-750-WD-40K	3,000	26	117
XBEAMD-4-750-WD-50K	3,000	25	122

Model	Lumens	Watts	LPW
XBEAMD-8-750-WD-30K	6,000	53	114
XBEAMD-8-750-WD-35K	6,000	51	117
XBEAMD-8-750-WD-40K	6,000	50	120
XBEAMD-8-750-WD-50K	6,000	48	125

## FINISHES

### STANDARD FINISHES



WHITE MINI TEXTURE

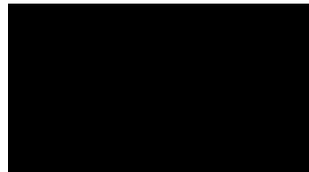

BLACK MINI TEXTURE

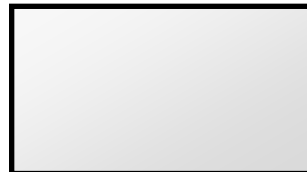

CLEAR ANODIZE

Type:	
Project:	
REP/Agent:	
Order #:	

## SPECIFICATIONS

### Housing

Nominal 2.7" x 4" square housing of continuous extruded 6063 T5 aluminum.

### Color

Colors for the housing are available in a powder coated white and black or clear anodize. Consult factory for custom colors.

### Luminaire Length

4' or 8' lengths are available for a single stand-alone section. Using internal joiners, 4' and 8' sections can be joined to form longer rows.

### End Caps

Injection molded flat end caps are mechanically attached with no exposed fasteners to enhance architectural aesthetic and prevent light leak. Machined end caps available.

### Source

Lumen packages are available in four color temperature options (3000K, 3500K, 4000K and 5000K) — all within 3 MacAdam ellipses.

### Certification

Intertek cETLus Listed. RoHS (Restriction of Hazardous Substances) and Buy American Act compliant.

### Battery

Philips Bodine lithium ion battery providing up to 720lm(6W) or up to 1200lm(10W) for 90 minutes. UL924 listed. Class 2 compliant. Meets Title 20 CEC (California Energy Commission) efficiency standards.

### Environment

Suitable for dry and damp locations.  
Operating temp.: -40°C to +50°C  
-40°F to +122°F

### Dimming Driver

Universal Lighting Technologies (ULT) Everline series of LED drivers allows tunable output currents to achieve infinite configurations of output. UL Class 2 recognized. 0-10v interface can be wired as Class 1 or Class 2 circuit. Included 2.5Kw ring and wave overcurrent protection, isolation of each individual output and a fully potted driver to protect from heat and vibration. Power factor <.93

### Packaging

Sustainably manufactured outside cardboard box and biodegradable, protective poly-foam luminaire inserts.

## COMPANION PRODUCTS

### X Beam Direct/Indirect

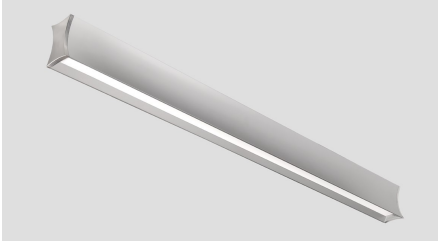

## Wireless Node



## WARRANTY

5-year limited warranty. Complete warranty terms can be located at:

[http://www.starteklightingamerica.com/images/pdf/warranty/Beam\\_Series\\_Warranty.pdf](http://www.starteklightingamerica.com/images/pdf/warranty/Beam_Series_Warranty.pdf)

Note: Actual performance may differ as a result of installation environment and final application. All values are design or typical values, measured under laboratory conditions, at 25°C (77°F) .