

Type:	
Project:	
REP/Agent:	
Order #:	

RECESSED SHALLOW BEAM

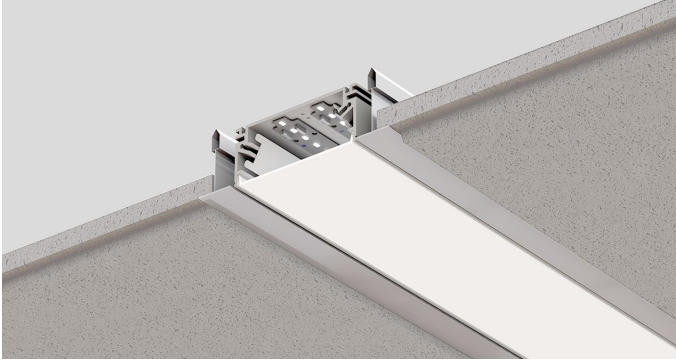

SHIELDING

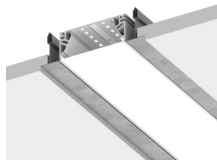

Flush

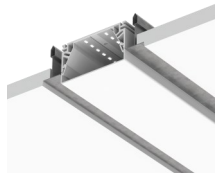

DLE .5

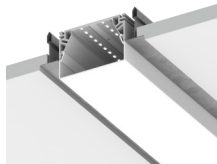

DLE 1

FEATURES

- ★ Soft diffused direct illumination in a sleek, modern, minimalist style
- ★ Continuous lensing standard– runs up to 100'
- ★ Extruded aluminum single piece housing
- ★ 2', 4', 6' and 8' individual units, or continuous rows
- ★ Light levels can be set to any combination at the factory
- ★ Powder coat finishes available in white and black
- ★ Approved for dry and damp locations
- ★ 0-10v dimming is standard
- ★ Dim to 1% of output current is standard
- ★ 120-277V power enclosure
- ★ Three power choices of Hyperdrive remote power system
- ★ 90 CRI (R9 50 min) available
- ★ 5 year system warranty
- ★ Class 2 input for luminaire
- ★ Field Fit available for wall-to-wall applications

DISTRIBUTION

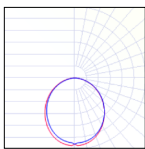

SD= SatinIce

DIMENSIONS

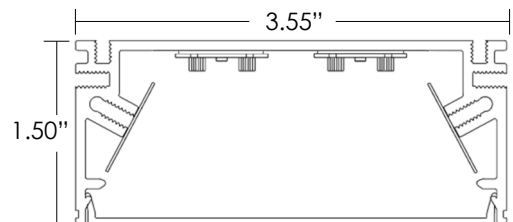

Type:	
Project:	
REP/Agent:	
Order #:	

RECESSED SHALLOW BEAM

SERIES	LENGTH	LUMENS/FOOT	DISTRIBUTION	CCT	CRI
RSHAL					
RSHAL	xx = Run Length Sxx = Symmetric Run Length _x_RECT = Rectangle _x_L = L-Shape _x_x_U = U-Shape	350 = 350 LPF 500 = 500 LPF 750 = 750 LPF 1000 =1000 LPF XXX = Custom LPF	SD = SatinIce Diffuse DLE05 = 0.5" Drop Lens w/ Lit Ends DLE10 = 1.0" Drop Lens w/ Lit Ends	27K = 2700K 30K = 3000K 35K = 3500K 40K = 4000K 50K = 5000K	80 = 80 90 = 90 <i>(R9 50 min)</i>

FINISH	MOUNTING	ELECTRICAL
<p>STANDARD</p> <p>PW= Powder Coat White PB= Powder Coat Black</p> <p>PREMIUM</p> <p>RALxxx= Powder Coat RAL xxxx (Gloss Finish)</p> <p>CUSTOM</p> <p>PO= Powder Other</p> <p>See pg. 10 for standard and premium finishes.</p>	<p>T-GRID</p> <p>TBX= 9/16" Grid 15/16" Grid TEG15= 15/16" Grid (Tegular Tile) TEG9= 9/16" Grid (Tegular Tile)</p> <p>COSMETIC BEZEL</p> <p>CB= Cosmetic Bezel (Screw/ Rod Mount) CBY= Cosmetic Bezel (Yoke Mount) *NOTE: Bezel color will match fixture color unless otherwise specified, consult factory for options.</p> <p>SPACKLE FLANGE</p> <p>SF= Spackle Flange (Screw/ Rod Mount) SFY= Spackle Flange (Yoke Mount)</p> <p>TRIMLESS</p> <p>TR= Trimless (Screw/ Rod Mount)</p> <p>*Items in grey box require Hyperdrive Remote Driver*</p>	<p>1C= Single Circuit MC= Multiple Circuits <i>(multiple switch legs across run length)</i></p>

OPTIONS	HYPERDRIVE CIRCUIT
<p>Ex= EM Battery designated fixture (Ordered with Hyperdrive) Replace X with battery Qty.</p> <p>TP= Top Power (Only available with the TBX configuration)</p> <p>TPBxx= Top Power with battery (Only available with the TBX configuration) xx= specify battery wattage 6W, 10W, or 14W</p> <p>FF3 = +/- 3" Field Fit FF6 = +/- 6" Field Fit</p>	<p>HDxx= HyperDrive Circuit Not required for the Top Power configuration</p>

EXAMPLE: RSHAL-04-750-SD-35K-90-PW-TBX-E1-HD01

Type:	
Project:	
REP/Agent:	
Order #:	

HYPER DRIVE REMOTE POWER SYSTEM

HYPD				
SERIES	SIZE / DRIVER QTY	EMERGENCY BATTERY (OPTIONAL)	MOUNTING	FINISH
HYPD	<p>Replace x with driver quantity</p> <p>Sx= Small– up to two drivers (190W)</p> <p>Mx= Medium– up to four drivers (300W)</p> <p>Lx= Large– up to eight drivers (600W)</p>	<p>Replace # with battery quantity</p> <p>NB= No Emergency Battery</p> <p>#EMB6= 6W EM Battery (Bodine)</p> <p>#EMB10= 10W EM Battery (Bodine)</p> <p>#FCEMB10= 10W EM Battery (Factory Choice)</p> <p><i>Note: Batteries are only available in Medium and Large enclosures. Each emergency battery reduces the driver quantity of the Hyper Drive.</i></p>	<p>S= Surface/ Strut</p> <p>R= Recessed</p>	<p>STANDARD</p> <p>PW= Powder Coat White</p> <p>PB= Powder Coat Black</p> <p>PREMIUM</p> <p>RALxxxx= Power Coat</p> <p>RAL xxxx (Gloss Finish)</p>

VOLTAGE	OPTIONS	HYPERDRIVE CIRCUIT
U= 120-277	<p>SPECIALTY DRIVERS (Standard driver is 0-10V, dim to 1% output current)</p> <p>DT1= eldoLED EcoDrive Dim to 1% (0-10V)</p> <p>DTZ= eldoLED SoloDrive Dim to 0.1% (0-10V)</p> <p>PSRD= Signify Sensor Ready (DALI) Driver</p> <p>LDE1= Lutron Hi-Lume EcoSystem LED driver w/ Soft-on, Fade-to-Black</p> <p>TW-A= Tunable White, 0-10v</p> <p>TW-EL= eldoLED DUALdrive Tunable White (DALI)</p> <p>Consult factory for additional driver options</p> <p><i>Note: Specialty driver options are not available with the small power-box option, with the exception of TW-A</i></p> <p>SENSORS</p> <p>Consult factory for options</p> <p>OTHERS</p> <p>CP= Chicago Plenum (CCEA)</p>	<p>HDxx= HyperDrive Circuit</p>

EXAMPLE: HYPD-L8-R-PW-DTZ-HD01

NOTES & LIMITATIONS

One driver is required per direct only fixture (8' max length)

Consult factory for custom configurations and drivers not listed.

L8 configuration shown (shown with front cover removed)

Each driver is provided with a terminal block on both input and output side for ease of wiring and installation.

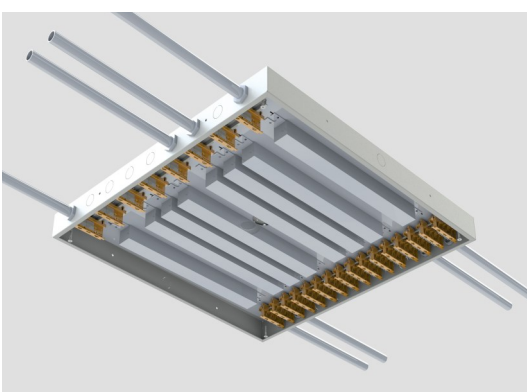

Sx (Small Hyper Drive Remote Canopy)

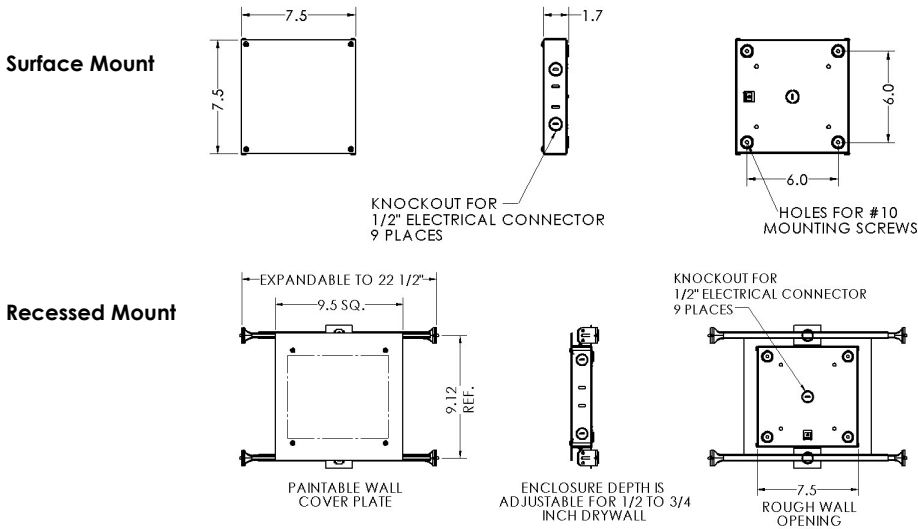

Driver Form Factor	Compact
Input Rating	120-277V
Outputs	Up to 2 (190W max)
Max Remote Distance	Up to 100' (30.5m)
Knockouts	(9) 1/2"
Battery	Not Available

Mx (Medium Hyper Drive Remote Canopy)

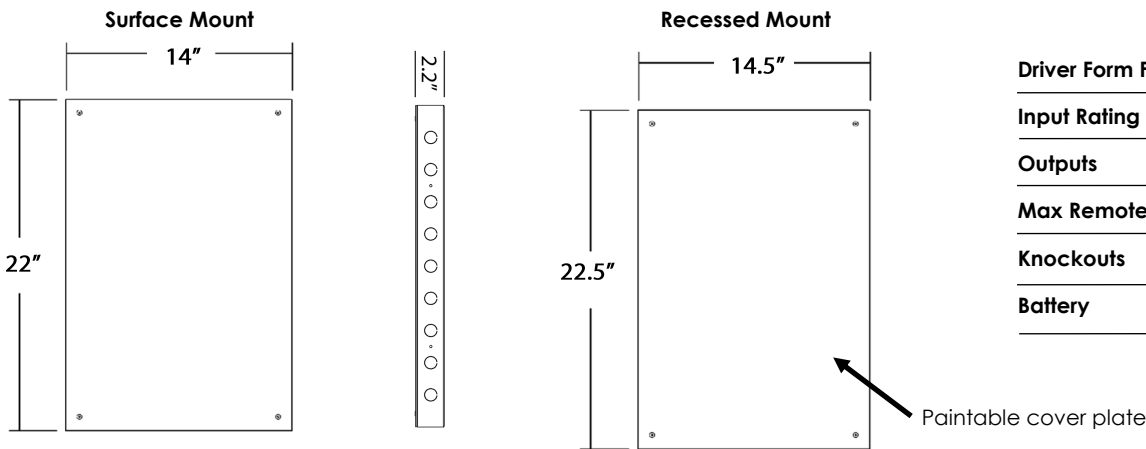

Driver Form Factor	Linear
Input Rating	120-277V
Outputs	Up to 4 (300W max)
Max Remote Distance	Up to 100' (30.5m)
Knockouts	(12) 1/2"
Battery	Available

Lx (Large Hyper Drive Remote Canopy)

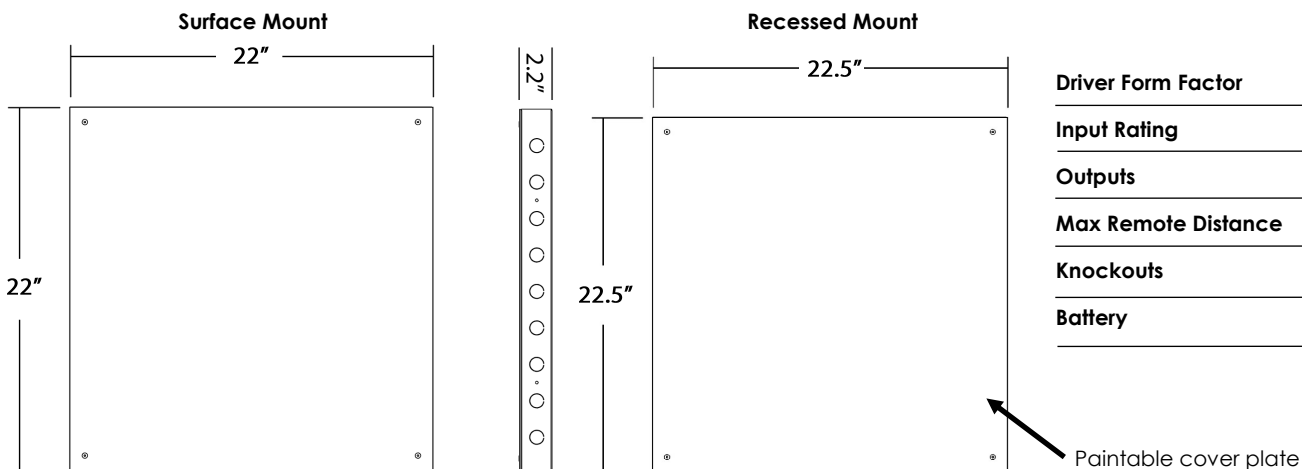

Driver Form Factor	Linear
Input Rating	120-277V
Outputs	Up to 8 (600W max)
Max Remote Distance	Up to 100' (30.5m)
Knockouts	(20) 1/2"
Battery	Available

How to use this guide

Fill out the worksheet to specify your requirements for your configurations. Be sure to callout battery and sensor locations.

Refer to the run chart for standard run configurations on linear lengths, consult factory for custom configurations.

Use the order guide to create your BOM for your configuration.

Submit the worksheet along with your order.

#1 Example Bill of Materials

Qty.	Type	
3	RSHAL-04-750-SD-35K-90-PW-TBX-HD01	
3	RSHAL-06-750-SD-35K-90-PW-TBX-HD01	
1	HYPD-L6-NB-R-PW-DTZ-HD01	

#1 Example Configuration

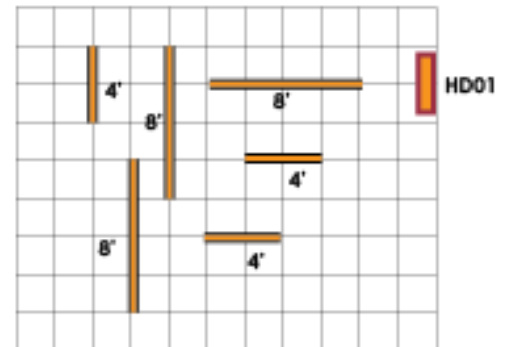

Note: Low Voltage Power transfer wire between Edsize and HyperDrive remote power system provided by others.

#2 Example Bill of Materials

Qty.	Type	
3	RSHAL-08-750-SD-35K-90-PW-TBX-HD01	
2	RSHAL-06-750-SD-35K-90-PW-TBX-HD01	
1	RSHAL-02-750-SD-35K-90-PW-TBX-HD01	
1	RSHAL-10-750-SD-35K-90-PW-TBX-HD01	
1	RSHAL-06-750-SD-35K-90-PW-TBX-E1-HD02	
1	RSHAL-10-750-SD-35K-90-PW-TBX-HD02	
1	HYPD-L8-NB-R-PW-DTZ-HD01	
1	HYPD-M3-1EMB6-R-PW-DTZ-HD02	

#2 Example Configuration

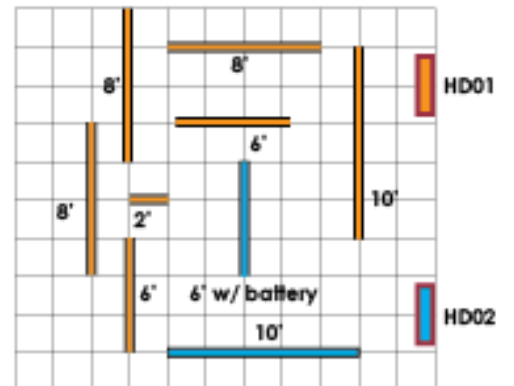

Note: Low Voltage Power transfer wire between Edsize and HyperDrive remote power system provided by others.

RECESSED SHALLOW BEAM

Power Options

TP - Top Power Option

Top mounted driver box can be mounted anywhere along the length of the fixture. Can fit applications where plenum space is tight in some areas but more open in others.

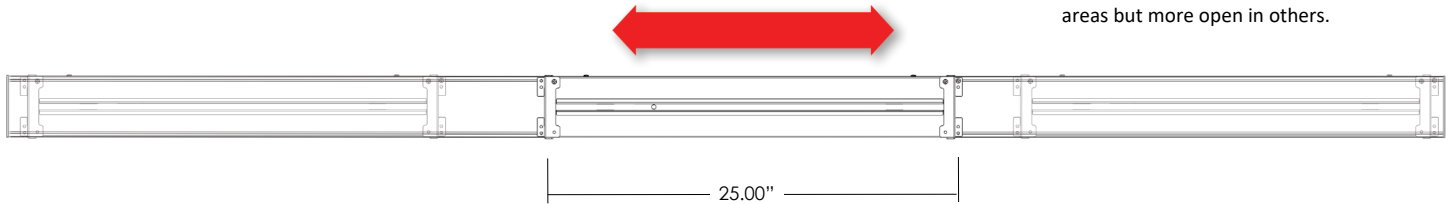

Driver and battery (only on TPBxx option) are mounted to side cover

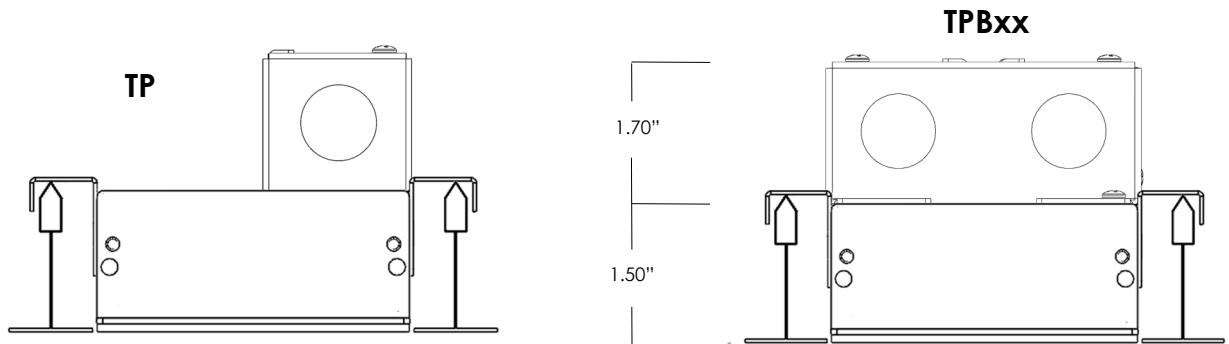

MOUNTING OPTIONS

T-BAR/T-GRID Options - TBX

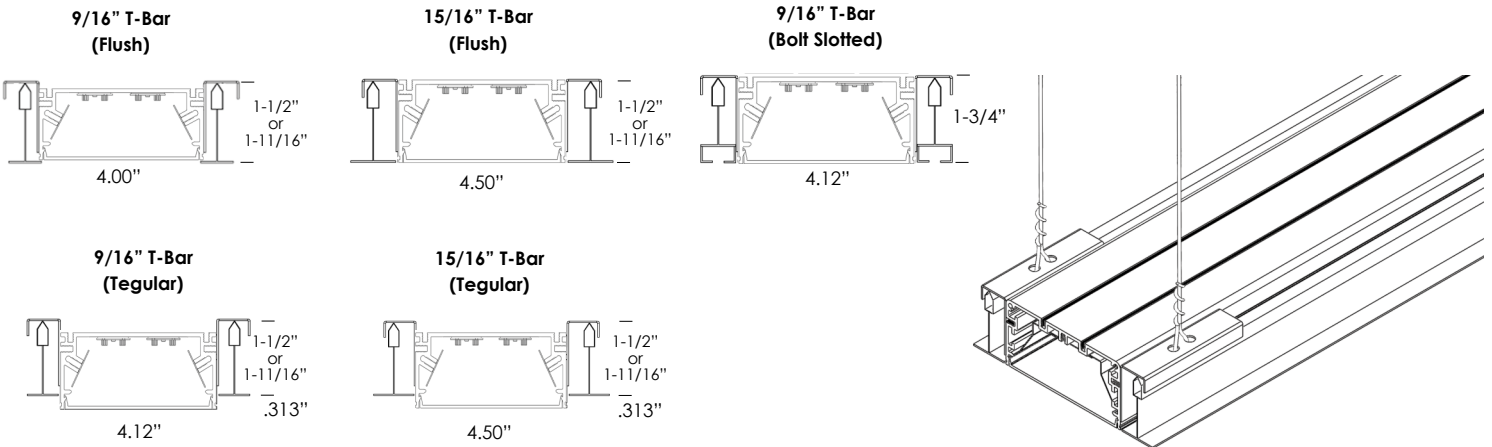

RECESSED SHALLOW BEAM

ROW CONFIGURATIONS

xx (Run Length)

The standard construction of run lengths follows the logic of the table below. Consult factory for additional information.

Run lengths always start with the longest fixture and receives the power feed.

		Total Length																																													
		2	3	4	5	6	7	8	9	10	11	12	13	14	15	16	17	18	19	20	21	22	23	24	25	26	27	28	29	30	31	32	33	34	35	36	37	38	39	40							
# of Sections	2	1																																													
	3		1								1							1																													
	4			1					1	1		1					1	1		1						1	1		1						1	1		1									
	5				1				1				1				1				1					1				1						1											
	6					1				1				1				1				1					1				1						1										
	7						1								1								1									1															
	8							1					1	1	1	1	1	1	2	1	1	2	2	2	2	2	2	3	2	2	3	3	3	3	3	3	3	4	3	3	4	4	4	4	4	4	5

NOTE: Fixtures in continuous runs are available in 6" increments. Consult factory for smaller increments.

MOUNTING OPTIONS AND DIMENSIONS

T-BAR/T-GRID Options - TBX

The lengths of individual fixtures and run lengths specified in the ordering logic is the distance between the centers of the T-Grids (See Page 4). The actual length of the fixtures and the lens will be shorter from that specified length. In a run, the last fixture compensates for the T-Grid. NOTE: The mounting option will affect total run length. If a different configuration is needed to meet an aesthetic requirement, please indicate this on your P.O. when placing your order.

Examples of the standard construction of TBX and TBA configurations are as follows:

TBX / TEG9

4' FIXTURE

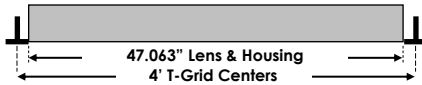

8' FIXTURE

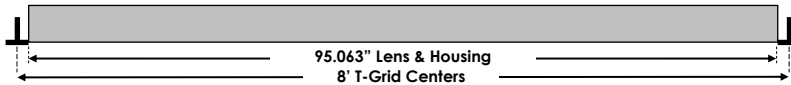

12' FIXTURE

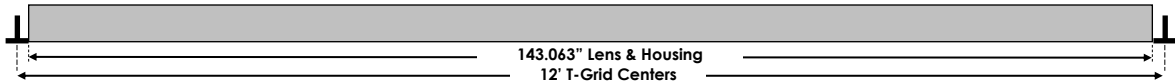

TEG15

4' FIXTURE

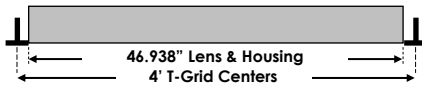

8' FIXTURE

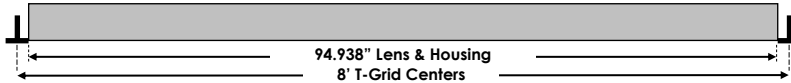

12' FIXTURE

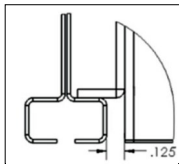
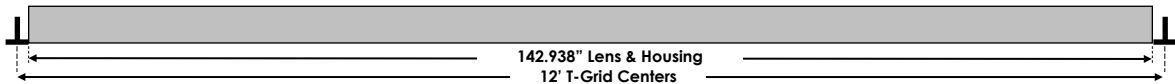

Detailed View
9/16" SCREW SLOT

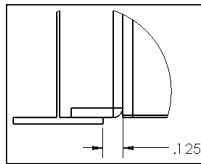

Detailed View
9/16" T-BAR

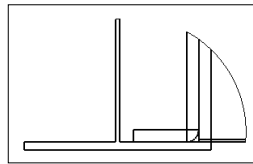

Detailed View
15/16" T-BAR

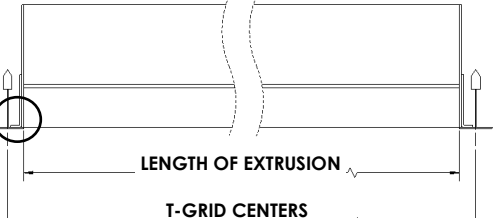

RECESSED SHALLOW BEAM

MOUNTING OPTIONS

Drywall Ceiling Mounting

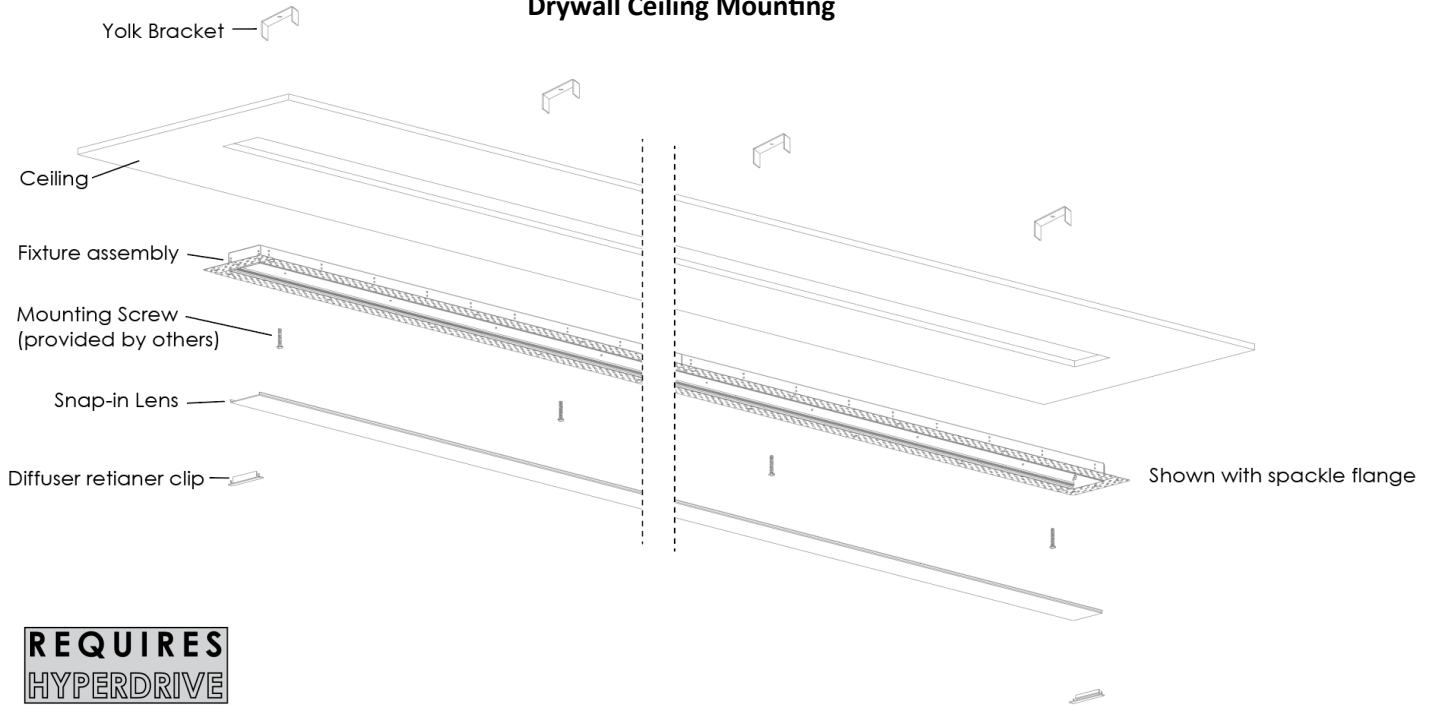

**REQUIRES
HYPERDRIVE**

CB - Cosmetic Bezel (Screw/ Rod Mount)

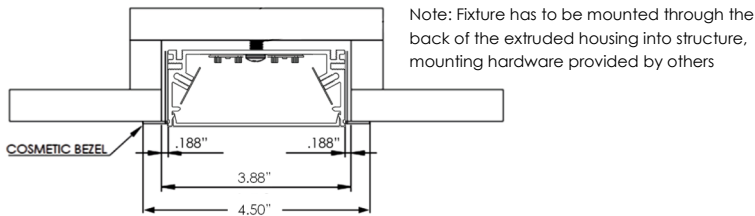

CBY - Cosmetic Bezel (Yoke Mount)

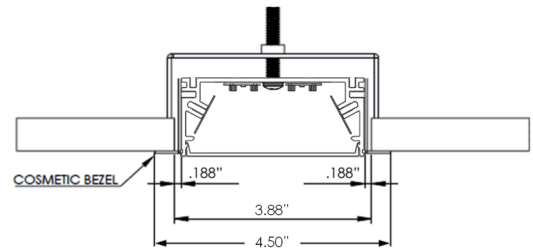

SF - Spackle Flange (Screw/ Rod Mount)

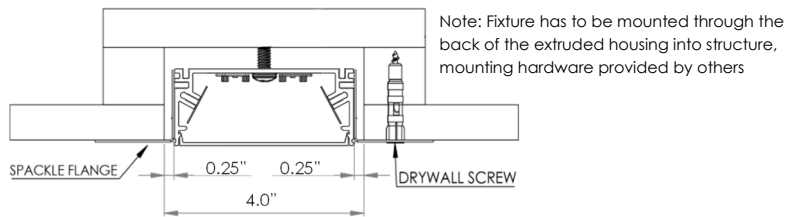

SFY - Spackle Flange (Yoke Mount)

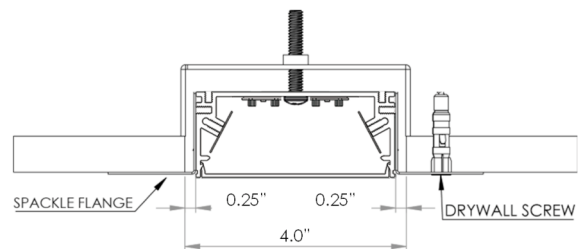

TR - Trimless

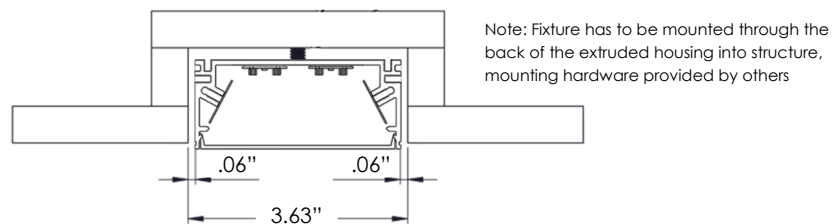

RECESSED SHALLOW BEAM

HOUSING OPTIONS

FF_ - Field Fit

This option allows for flexibility in wall-to-wall recessed applications. When ordered, the total run length allows for $\pm 3.0"$ or $\pm 6.0"$. Housing must be cut in the field with a miter saw based on required dimensions.

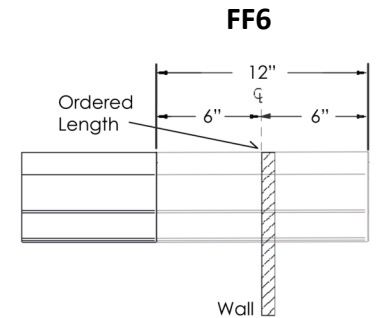
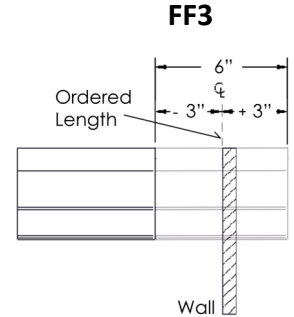
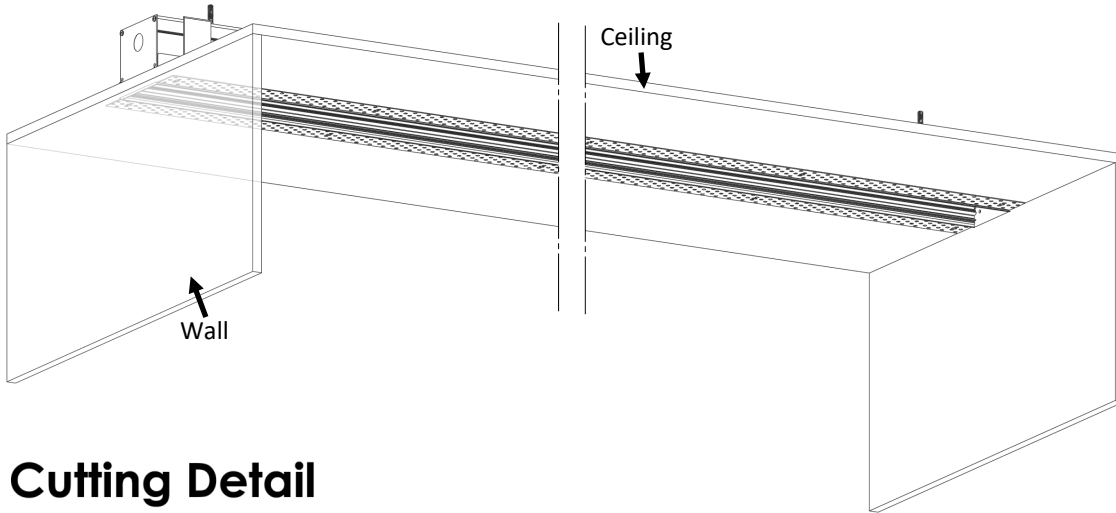

Cutting Detail

Step 1.
Remove the endcap before cutting the back extrusion.

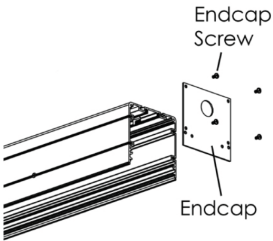

Step 2.
Cut back extrusion. Cut all trim accordingly.

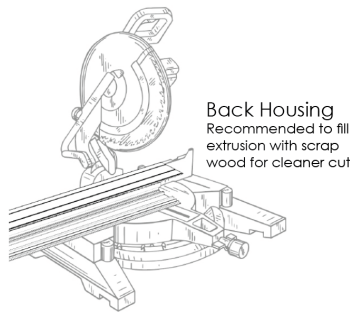

Step 3.
Reinstall endcap. Reinstall telescoping lighting assembly and slide to the end.

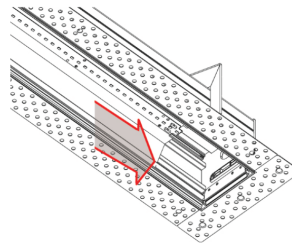

SHAPE CONFIGURATION WITH MITER CUTS

Specify the configuration and overall dimensions. Note the overall dimension is for the fixture and does not include any mounting brackets or accessories. For the "L" shape, the standard construction is to build with as many 8' sections as possible or use the longest sections first and finish the shapes with a shorter length fixture if necessary.

_x_RECT
RECTANGLE
SUPPLY AxB DIMENSIONS

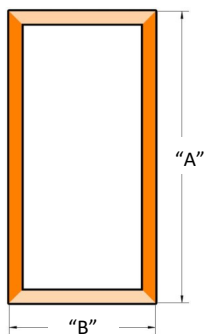

_x_L
L-SHAPE
SUPPLY AxB DIMENSIONS

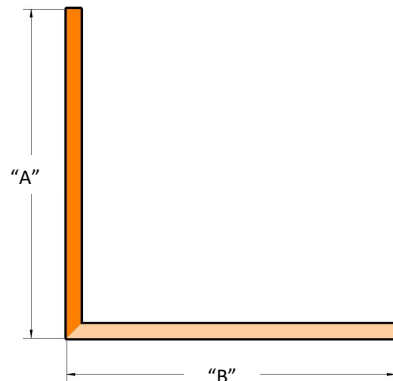

_x_x_U
U-Shape
Supply AxBxC dimensions

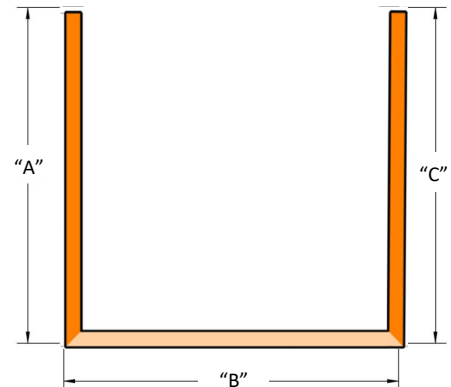

RECESSED SHALLOW BEAM

PERFORMANCE

RMBEAM-X-1000-SD (80+ CRI)

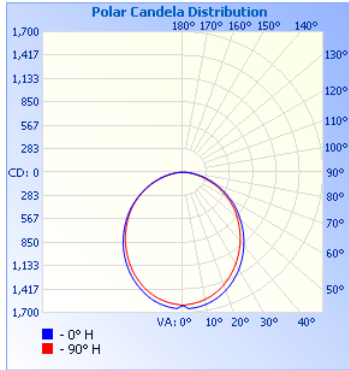

Zonal Lumen Summary		
Zone	Lumens	% Luminaire
0-30	1227.4	28.3%
0-40	1984.3	45.8%
0-60	3435.2	79.3%
60-90	898.1	20.7%
70-100	382.5	8.8%
90-120	0	0%
0-90	4333.3	100%
90-180	0	0%
0-180	4333.3	100%

Model	Lumens	Watts	LPW
RMBEAM-4-1000-SD-27K-80-SM-U	4000	45	88
RMBEAM-4-1000-SD-30K-80-SM-U	4000	43	93
RMBEAM-4-1000-SD-35K-80-SM-U	4000	40	98
RMBEAM-4-1000-SD-40K-80-SM-U	4000	40	100
RMBEAM-4-1000-SD-50K-80-SM-U	4000	39	101

Model	Lumens	Watts	LPW
RMBEAM-8-1000-SD-27K-80-SM-U	8000	86	92
RMBEAM-8-1000-SD-30K-80-SM-U	8000	82	97
RMBEAM-8-1000-SD-35K-80-SM-U	8000	78	102
RMBEAM-8-1000-SD-40K-80-SM-U	8000	76	104
RMBEAM-8-1000-SD-50K-80-SM-U	8000	76	105

Luminance Data (cd/sg.m)			
Angle in Degrees	Average 0-DEG	Average 45-Deg	Average 90-Deg
45	38908	37508	36548
55	37012	35568	34838
65	34443	32866	31959
75	31102	29125	26942
85	27230	23857	19189

Candela Distribution					
	0	22.5	45	67.5	90
0	1615	1615	1615	1615	1615
5	1649	1617	1598	1589	1595
10	1626	1592	1573	1561	1565
15	1584	1549	1529	1515	1518
20	1524	1486	1470	1452	1453
25	1448	1413	1398	1377	1375
30	1361	1325	1312	1290	1285
35	1261	1227	1217	1194	1187
40	1152	1121	1113	1092	1086
45	1039	1008	1001	984	976
50	920	892	886	871	865
55	801	777	770	760	754
60	677	655	647	640	634
65	550	532	524	517	510
70	425	411	402	393	385
75	304	294	285	274	263
80	190	184	176	164	155
85	90	83	78	69	63
90	0	0	0	0	0

FINISHES

STANDARD FINISHES



WHITE MINI TEXTURE

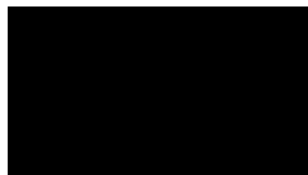

BLACK MINI TEXTURE

RECESSED SHALLOW BEAM

SPECIFICATIONS

Housing

Nominal 1.5" x 3.6" x .06" thick housing of continuous extruded 6063 T5 aluminum.

Color

Colors for the housing are available in a powder coated white, black, silver, and woodgrain with end cap to match. Consult factory for custom colors.

Luminaire Length

2', 4', 6' or 8' lengths are available for a single stand-alone section. Using internal joiners, these sections can be joined to form longer rows.

End Caps

Flat end caps are mechanically attached with screws and have gaskets to prevent light leak.

Source

Lumen packages are available in five color temperature options (2700K, 3000K, 3500K, 4000K and 5000K) — all within 3 MacAdam ellipses.

Certification

Intertek cETLus Listed. RoHS (Restriction of Hazardous Substances) and Buy American Act compliant.

Battery

Signify battery providing up to 780lm(6W) or up to 1300lm(10W) for 90 minutes. UL924 listed. Class 2 compliant. Meets Title 20 CEC (California Energy Commission) efficiency standards. Requires Hyperdrive medium or large as well as Test/ Status switch is located on "HyperDrive"

Lensing

0.060" thick impact resistant acrylic lensing.

Environment

Suitable for dry and damp locations.

Operating temp.: -40°C to +50°C
-40°F to +122°F

Dimming Driver

UL listed, class P (0-10V) dimming driver with programmable current for configurable fixture lumen outputs. 2.5 KV overcurrent protection
Power factor >.9

Packaging

Sustainably manufactured outside cardboard box and biodegradable, protective poly-foam luminaire inserts.

COMPANION PRODUCTS

Micro Beam Direct/Indirect

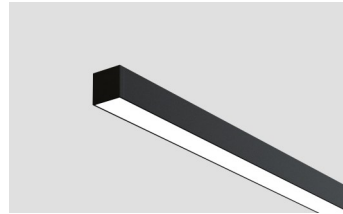

Micro Beam Surface Mount

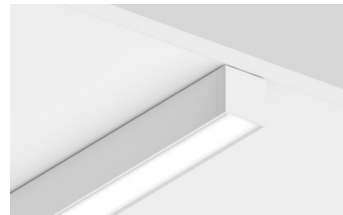

WARRANTY

5-year limited warranty. Complete warranty terms can be located at:

http://www.starteklightingamerica.com/images/pdf/warranty/MicroBeam_Series_Warranty.pdf

Note: Actual performance may differ as a result of installation environment and final application.
All values are design or typical values, measured under laboratory conditions, at 25°C (77°F) .